

# PosiTector® 6000 Series

Coating Thickness Gages for  
**ALL** Metal Substrates



# PosiTector® 6000 Series

## All Gages Feature...

### Simple

- Ready to measure—no calibration adjustment required for most applications
- One-handed menu navigation
- Bi-color indicator light—ideal in a noisy environment
- RESET feature instantly restores factory settings

### Durable

- Solvent, acid, oil, water and dust resistant—meets or exceeds IP5X
- Wear-resistant probe tip
- Scratch/solvent resistant display suitable for harsh environments
- Shock-absorbing, protective rubber holster with belt clip
- Two year warranty

### Accurate

- Certificate of Calibration showing traceability to NIST included
- Built-in temperature compensation ensures measurement accuracy
- Hi-RES mode increases displayed resolution for use on applications that require greater precision
- Conforms to national and international standards including ISO and ASTM

### Versatile

- Multiple calibration adjustment options including 1 point, 2 point, known thickness, average zero
- Selectable display languages
- Backlit display for dim or dark environments
- MILS/Microns/mm switchable
- Extended cables available (up to 250 ft/75 m) for remote measuring



*Flip Display enables right-side-up viewing*

*Protective rubber holster with quick-release belt clip and probe storage*



## Easy steps to select a gage...

### Select substrate

- F — for ferrous metals (steel and cast iron)
- N — for non-ferrous metals (aluminum, copper, etc.)
- FN — for all metal substrates—Gage automatically recognizes the substrate and takes a measurement

### Select from a variety of measurement ranges and probe styles (see back page ordering guide)

*Built-in Probe Style. Ideal for one-handed operation*



*Separate Probe Style. Various probes available. Separate probes are fully interchangeable to provide maximum versatility.*

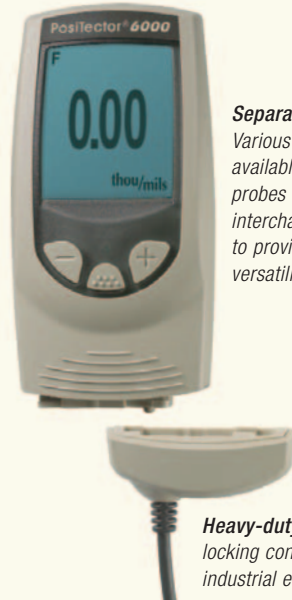

*Heavy-duty, gold-plated locking connector for industrial environments*

### Select Basic, Standard or Memory model

#### Basic (1) Models

*Includes all features as shown on left*

#### Standard (2) Models

*All Basic (1) Gage Features plus...*

- Storage of up to 250 readings
- Continually displays/updates average, standard deviation, min/max thickness and number of readings while measuring
- HiLo alarm audibly and visibly alerts when measurements exceed user-specified limits
- Built-in IR port for printing to optional wireless printer
- USB port for simple connection to a PC
- Optional PosiSoft software available for downloading readings to a PC for charting and graphing
- Optional serial output cable for data collectors

#### Memory (3) Models

*All Basic (1) and Standard (2) Gage Features plus...*

- Storage of 10,000 readings in up to 1000 batches—stored readings can be sub-grouped, viewed, updated or deleted
- Built-in clock to date and time stamp each stored measurement
- SSPC-PA2 feature determines if film thickness over a large area conforms to user-specified min/max levels
- Multiple stored calibration adjustments for measuring on a variety of substrate conditions
- Supplied with PosiSoft software and USB cable
- Now with  Bluetooth® Wireless Technology for immediate data transfer



## Tough **NEW** Features

- **USB/Serial/IR Ports** for downloading to a PC, printer or data collector (2 and 3 models only)

- **Solvent, acid, oil, water and dust resistant**—meets or exceeds IP5X

- **Scratch and solvent resistant lens**

**Memory (3) model shown in Memory Mode**

- **Thick impact-resistant Lexan® display**

- **Bi-color indicator light**

- **Hi-grade, industrial strength housing**

- **Shock-absorbing, protective rubber holster**

- **Quality high-flex cable and strain relief**

- **Stainless steel probe with knurled fingergrip**

- **Strong wear-resistant ruby-tipped probe**

*All Regular Separate Probes suitable for underwater use*

## Options

**PosiSoft® for Windows® analysis software** available for Standard (2) models, included with all Memory (3) models.

- Allows entry of notes and annotations
- Prints and displays basic charts and histograms
- Exports to a document or spreadsheet
- Includes USB cable
- Free updates

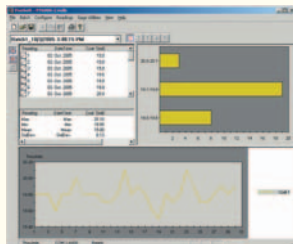

**IR Printer** receives data from Standard (2) and Memory (3) models via wireless infrared.

**Coating Thickness Standards** to fulfill both ISO and in-house quality control requirements.

**AC Power Cable** for continuous operation.

**Serial Output Cable** to connect to a data collector.

**Probe Fixture Stand** ensures repeatable positioning.



## Probes available for a variety of applications

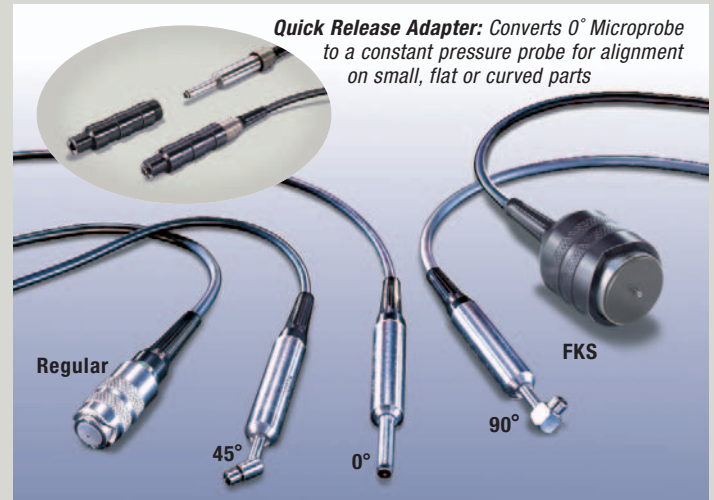

*For measuring paint, powder, etc. on all metals...*

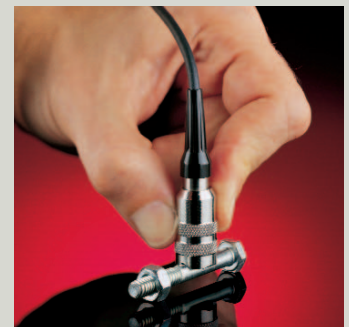

*...and for measuring galvanizing, plating, anodizing and more.*









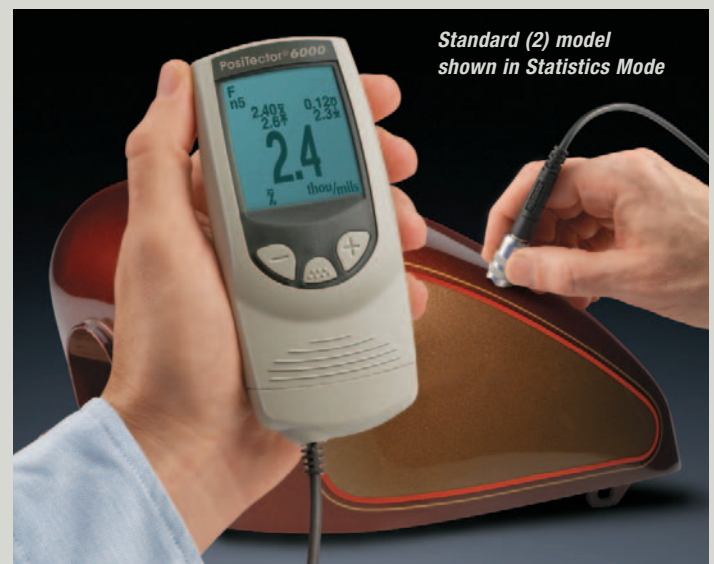



**Microprobe series** for small parts and hard-to-reach areas



**High-Range Probes** for thick coatings, e.g. fire proofing, tank linings, etc.



Visit [www.defelsko.com/applications.htm](http://www.defelsko.com/applications.htm) to view **Coating Inspection Application Notes**.

<b>PosiTector® 6000 Series</b>  <b>ORDERING GUIDE</b>		Our most popular built-in and Regular separate probe models			90° Regular probe for tight spots	Ideal for anodized aluminum	Microprobes – Our smallest probes for small parts or hard-to-reach areas			Built-in and Separate probes for thick protective coatings; epoxy, rubber, intumescent fire proofing and more		
												
Non-Magnetic Coatings over FERROUS Metals (Steel & Iron)	Basic	F1	FS1	FRS1		F0S1	F45S1	F90S1	FT1	FTS1	FKS1	
	Standard	F2	FS2	FRS2		F0S2	F45S2	F90S2	FT2	FTS2	FKS2	
	Memory	F3	FS3	FRS3		F0S3	F45S3	F90S3	FT3	FTS3	FKS3	
Non-Conductive Coatings on NON-FERROUS Metals (Aluminum, Copper, etc.)	Basic	N1	NS1	NRS1	NAS1	N0S1	N45S1	N90S1			NKS1	
	Standard	N2	NS2	NRS2	NAS2	N0S2	N45S2	N90S2			NKS2	
	Memory	N3	NS3	NRS3	NAS3	N0S3	N45S3	N90S3			NKS3	
Combination ALL METALS	Basic	FN1	FNS1	FNRS1						FNTS1		
	Standard	FN2	FNS2	FNRS2						FNTS2		
	Memory	FN3	FNS3	FNRS3						FNTS3		
Range		0 – 60 mils 0 – 1500 µm			Ferrous: 0 – 45 mils and 0 – 1150 µm Non-Ferrous: 0 – 25 mils and 0 – 625 µm			0 – 250 mils 0 – 6 mm		0 – 500 mils 0 – 13 mm		
Accuracy*		±(0.05 mils + 1%) 0 – 2 mils ±(0.1 mils + 1%) > 2 mils ±(1 µm + 1%) 0 – 50 µm ±(2 µm + 1%) > 50 µm			±(0.02 mils + 1%) 0 – 4 mils ±(0.1 mils + 3%) > 4 mils ±(0.5 µm + 1%) 0 – 100 µm ±(2 µm + 3%) > 100 µm			±(0.5 mil + 1%) 0 – 100 mils ±(0.5 mil + 3%) > 100 mils ±(0.01 mm + 1%) 0 – 2.5 mm ±(0.01 mm + 3%) > 2.5 mm		±(1 mil + 3%) 0 – 500 mils ±(0.02 mm + 3%) 0 – 13 mm		
Matching DeFelsko Calibration Standards		CAL-S1 CAL-A1			CAL-S2 CAL-A2			CAL-P1		CAL-P5		

\*Accuracies are stated as a fixed value plus a percentage of the gage's actual reading. EXTENDED CABLES available up to 250 ft / 75 m for underwater or remote measuring. Specify length when ordering.

## Probe Details

BUILT-IN	REGULAR & FTS	90° REGULAR	F0S & N0S with adapter	F45S & N45S	F90S & N90S	FNTS, FKS & NKS
----------	---------------	-------------	------------------------	-------------	-------------	-----------------

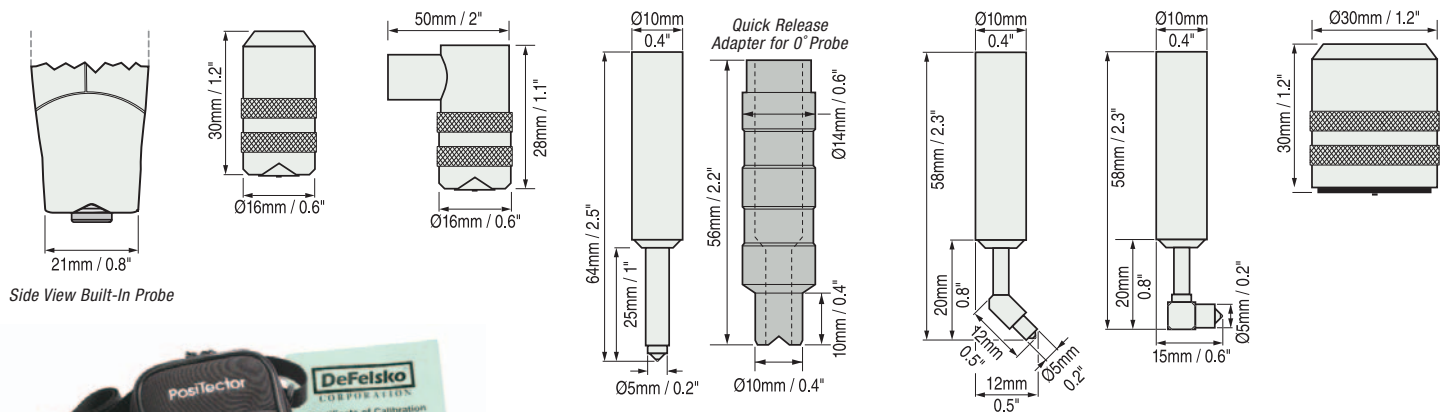

Side View Built-In Probe



**ALL GAGES COME COMPLETE** with precision plastic shims, protective rubber holster with belt clip, 3 AAA batteries, instructions, wrist strap (built-in style only), nylon carrying case with shoulder strap, Certificate of Calibration traceable to NIST, two (2) year warranty.

**MEMORY (3) GAGES** also include PosiSoft Windows-based Analysis Software, USB cable.

**SIZE:** 146 x 64 x 31 mm (5.75" x 2.5" x 1.2") **WEIGHT:** 165 g (5.8 oz.) without batteries

Conforms to ISO 2178/2360/2808, PrEN ISO 19840, ASTM B499/D1186/D1400/D7091/E376/G12, BS3900-C5, SSPC-PA2 and others

**DeFelsko®**  
The Measure of Quality

**DEFELSKO CORPORATION**  
802 Proctor Ave., P.O. Box 676, Ogdensburg, NY 13669 USA  
Toll Free 1-800-448-3835 Phone: 315-393-4450  
FAX: 315-393-8471 E-mail: techsale@defelsko.com  
Web: www.defelsko.com

  
Made in U.S.A.